



# MP3801

## 190Vpp High Voltage EL Lamp Driver

The Future of Analog IC Technology®

### DESCRIPTION

The MP3801 is a high output voltage, DC to AC converter designed for driving Electroluminescent (EL) lamps of up to 5 square inches. The device operates from an input voltage range of 2.5V to 5.5V, making it suitable for 1-cell Li-Ion and 2 or 3-cell alkaline/NiCad/NiMH battery applications. The device uses a single inductor and a minimum number of passive components. The MP3801 converts a low-voltage DC input to a  $\pm 95V$  regulated output voltage that drives the EL lamp.

The MP3801 is comprised of two stages: a boost stage and a H-bridge lamp driver stage. The boost stage converts the input voltage up to 95V. The H-bridge stage alternately switches the 95V to each terminal of the EL lamp.

The MP3801 has two separate internal oscillators for the boost and H-bridge stages. The frequency of each oscillator is set independently via external resistors. This flexibility allows the EL lamp circuit to be optimized for maximum performance. Also, the IC can be enabled /disabled by connecting these two resistors to  $V_{DD}/GND$ .

The MP3801 is available in an 8-pin MSOP package.

### FEATURES

- 2.5V to 5.5V DC Input Voltage
- 190V<sub>PP</sub> Regulated AC Output Waveform
- Single Cell Lithium-Ion Compatible
- 10nA Shutdown Current
- Adjustable EL Lamp Frequency
- Adjustable Converter Frequency
- Available in MSOP-8
- Split Supply Capability

### APPLICATIONS

- Portable Multimedia Players
- LCD Backlighting
- PDAs
- Handheld Wireless Communication
- Mobile Phones
- Remote Controls
- Global Positioning Systems (GPS)

"MPS" and "The Future of Analog IC Technology" are Registered Trademarks of Monolithic Power Systems, Inc.

### TYPICAL APPLICATION

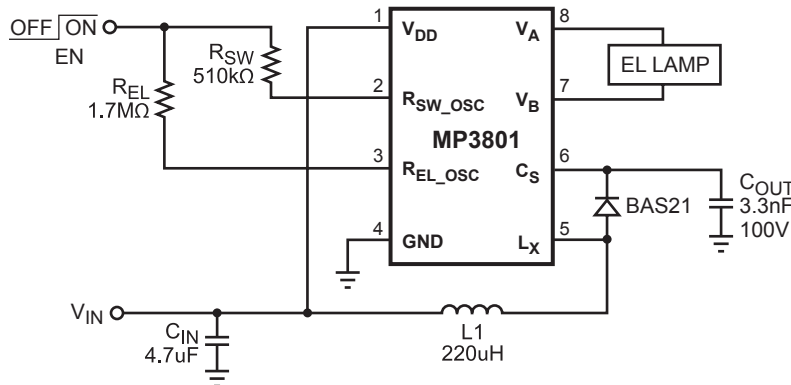

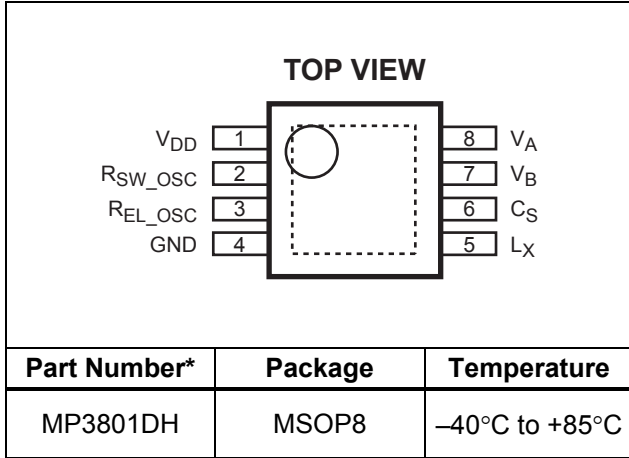
**PACKAGE REFERENCE**

\* For Tape & Reel, add suffix -Z (eg. MP3801DH-Z)  
 For RoHS Compliant Packaging, add suffix -LF  
 (eg. MP3801DH-LF-Z)

**ABSOLUTE MAXIMUM RATINGS <sup>(1)</sup>**

Supply Voltage ( $V_{DD}$ ) ..... -0.5V to +6.0V  
 Output Voltage ( $V_{CS}$ ,  $V_A$ ,  $V_B$ )..... -0.5V to +120V  
 All Other Pins..... -0.5V to  $V_{DD} + 0.3V$   
 Junction Temperature..... 150°C  
 Lead Temperature ..... 260°C  
 Storage Temperature ..... -65°C to +150°C

**Recommended Operating Conditions <sup>(2)</sup>**

Supply Voltage ..... 2.5V to 5.5V  
 Lamp Drive Frequency ( $f_{EL}$ ) ..... 60Hz to 1KHz  
 Switching Transistor Freq..... 50KHz to 200KHz  
 Operating Temperature ..... -40°C to +85°C

**Thermal Resistance (3)  $\theta_{JA}$   $\theta_{JC}$** 

MSOP8 ..... 150 ..... 65... °C/W

**Notes:**

- 1) Exceeding these ratings may damage the device.
- 2) The device is not guaranteed to function outside of its operating conditions.
- 3) Measured on approximately 1" square of 1 oz copper.

**ELECTRICAL CHARACTERISTICS**

$V_{IN} = V_{DD} = 3.0V$ ,  $R_{EL} = 1.7M\Omega$ ,  $R_{SW} = 510K\Omega$ ,  $T_A = +25^\circ C$ , unless otherwise noted.

Parameter	Symbol	Condition	Min	Typ	Max	Units
On Resistance of Switching Transistor	$R_{DS(ON)}$	$I_{SW} = 100mA$ , $V_{CS} = 95V$		9		$\Omega$
Output Voltage Regulation	$V_{CS}$		90	95	100	V
Peak to Peak Output Voltage	$V_A - V_B$		180	190	200	V
Input Low Voltage (Turn Off)	$V_{EN-L}$			$V_{DD} - 0.6$		V
Input High Voltage (Turn On)	$V_{EN-H}$			$V_{DD} - 0.3$		V
Shutdown Current	$I_{SD}$	$V_{EN} = 0V$		10		nA
Input Supply Current	$I_{VDD}$	$V_A, V_B$ Open, $V_{EN} = V_{IN}$		92		A
Input Current Including Inductor Current	$I_{IN}$	A 2k $\Omega$ resistor is series with a 10nF capacitor connected between $V_A$ and $V_B$		20		mA
EL Lamp Frequency	$f_{EL}$		200	240	274	Hz
Switching Transistor Frequency	$f_{SW}$			85		KHz
Switching Transistor Duty Cycle	D			92		%

**Note:**

4) Shutdown current is defined as the sum of currents going into  $V_{DD}$ ,  $V_{CS}$ , and SW nodes.

## PIN FUNCTIONS

Pin #	Name	Description
1	V <sub>DD</sub>	Supply Voltage.
2	R <sub>SW_osc</sub>	Boost Converter Frequency Setting Pin. Refer the frequency setting curve in the typical performance characteristics.
3	R <sub>EL_osc</sub>	EL Driver Frequency Setting Pin. Roughly, $f_{EL} = \frac{1.7M\Omega \times 240Hz}{R_{EL}}$
4	GND	Ground. Connect the exposed pad to this pin.
5	L <sub>X</sub>	Boost Converter Switching Pin. This pin connects to the N-Channel MOSFET drain.
6	C <sub>S</sub>	Boost Converter Output. Put a 100V, NPO ceramic capacitor at this pin to store the energy transferred from the inductor.
7	V <sub>B</sub>	Output Voltage B on EL Device.
8	V <sub>A</sub>	Output Voltage A on EL Device.

**TYPICAL PERFORMANCE CHARACTERISTICS**

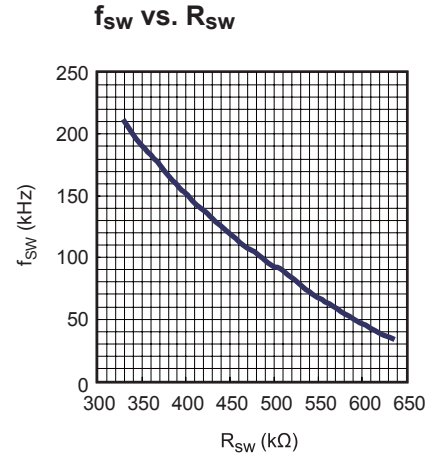
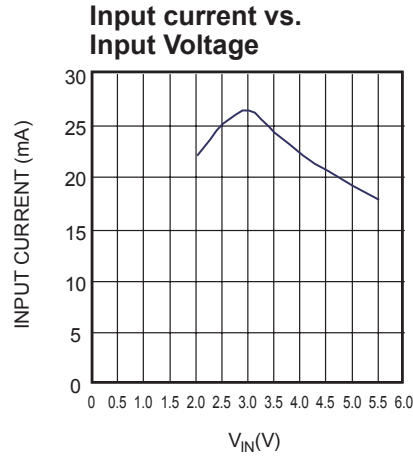
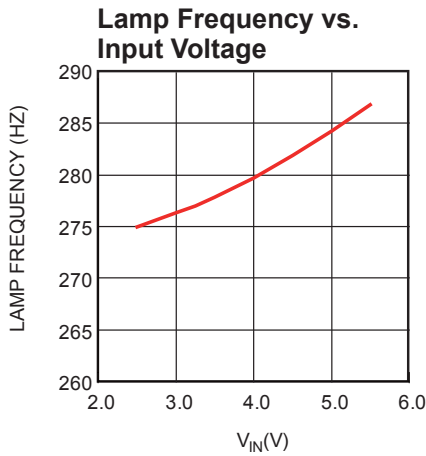

**2.5V Operation: 25°C**

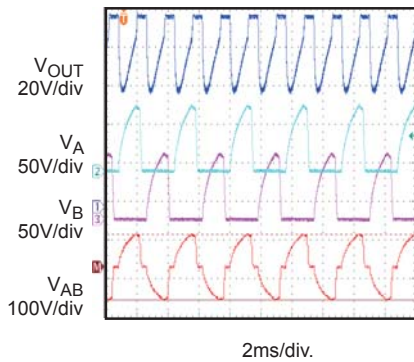

**3.5V Input Operation: 25°C**

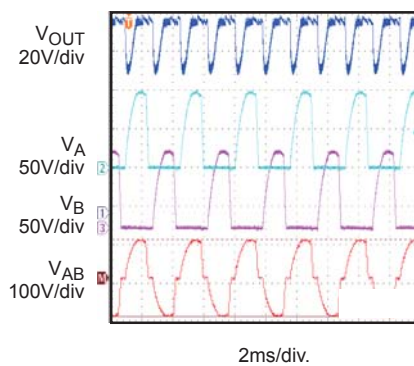

**4.5 Input Operation: 25°C**

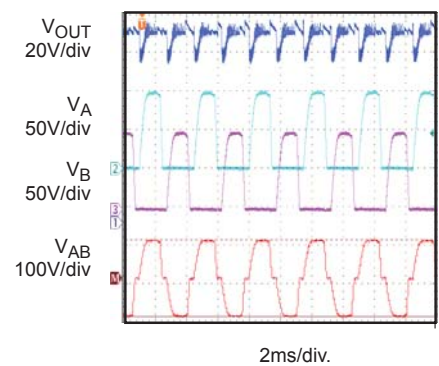

**5.5 Input Operation: 25°C**

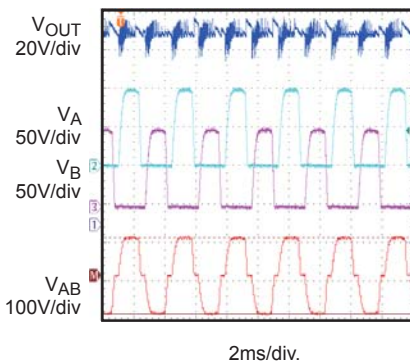

**2.5V Input Operation: -40°C**

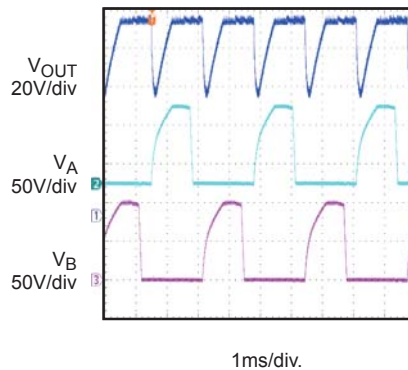

**3.5V Input Operation: -40°C**

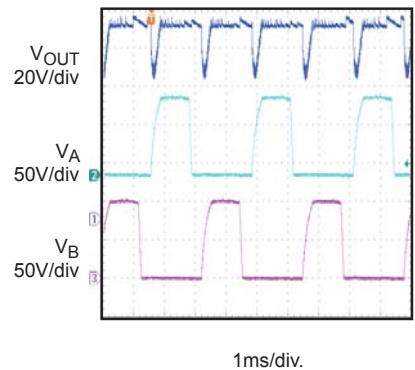

**TYPICAL PERFORMANCE CHARACTERISTICS (continued)**

4.5V Input Operation: -40°C

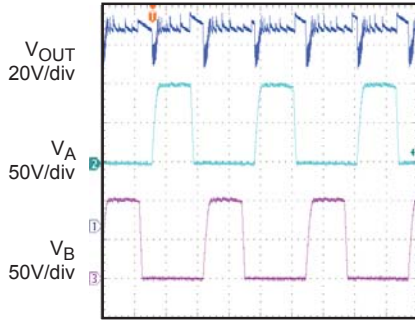

1ms/div.

5.5V Input Operation: -40°C

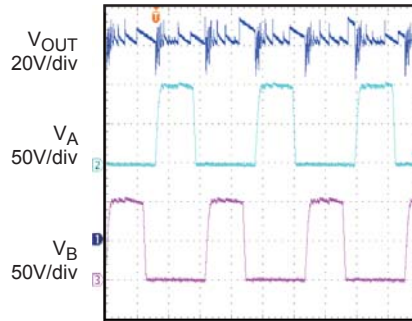

1ms/div.

2.5V Input Operation: 80°C

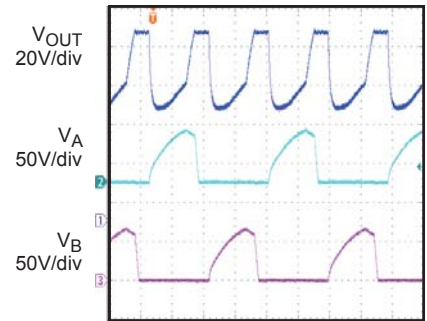

1ms/div.

3.5V Input Operation: 80°C

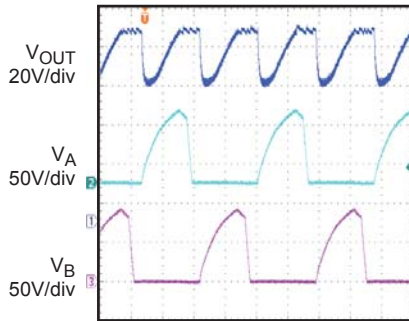

1ms/div.

4.5V Input Operation: 80°C

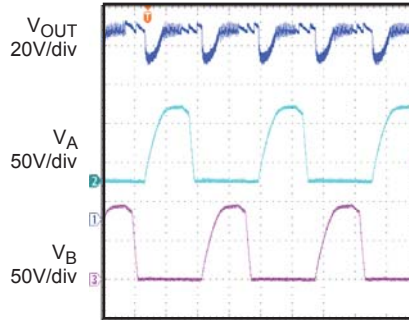

1ms/div.

5.5V Input Operation: 80°C

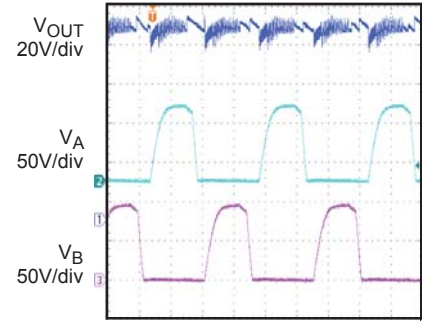

1ms/div.

**BLOCK DIAGRAM**

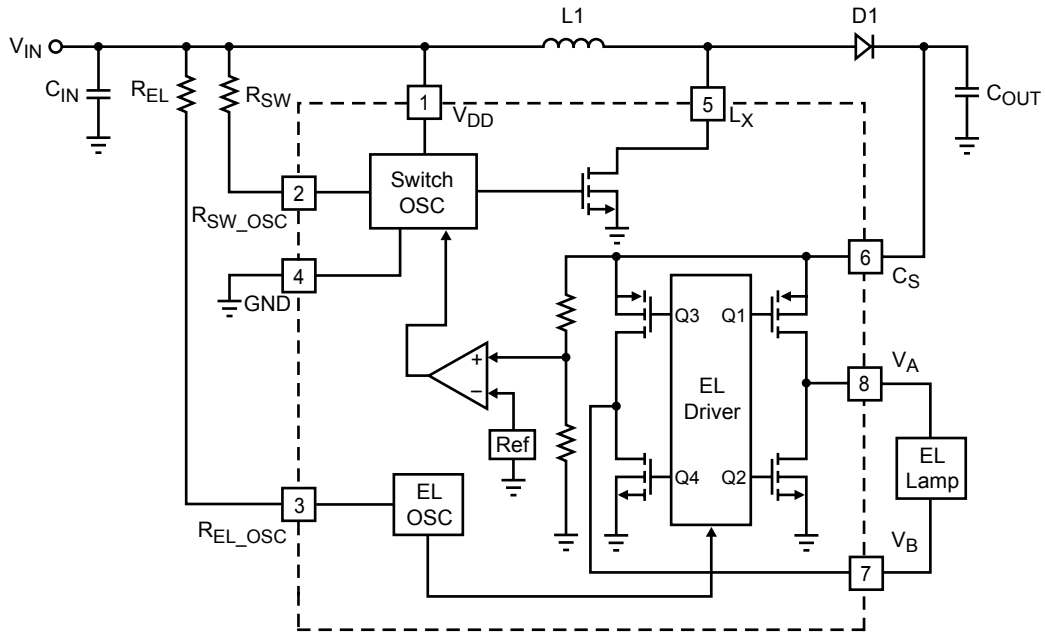

**Figure 1—Functional Block Diagram**

## PACKAGE INFORMATION

### MSOP8

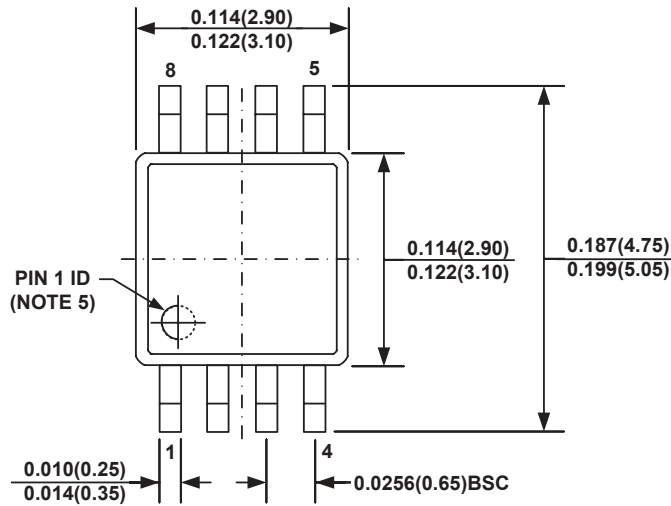

**TOP VIEW**

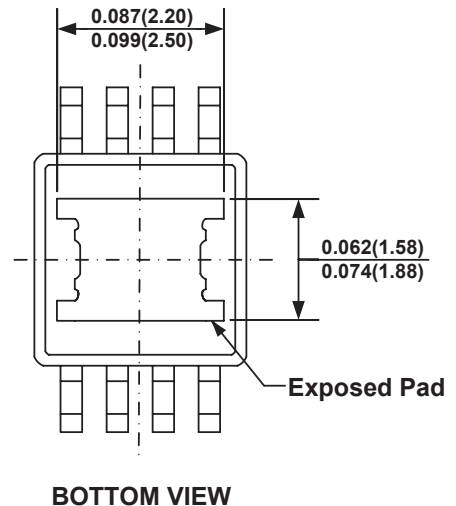

**BOTTOM VIEW**

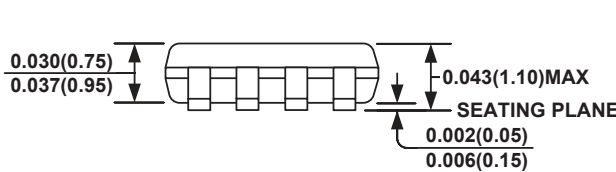

**FRONT VIEW**

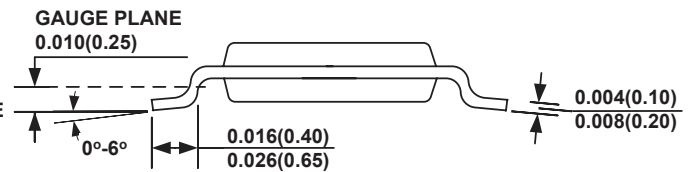

**SIDE VIEW**

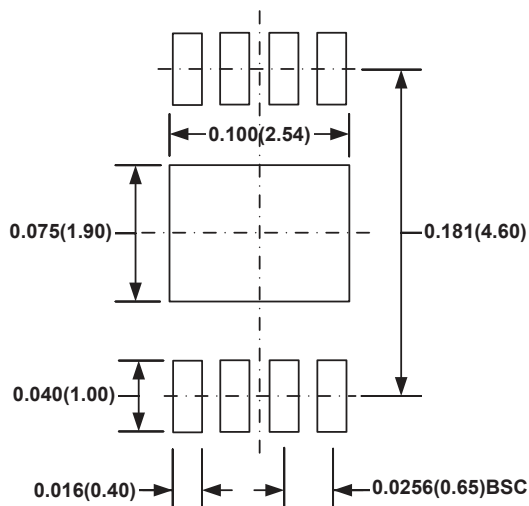

### RECOMMENDED LAND PATTERN

### NOTE:

- 1) CONTROL DIMENSION IS IN INCHES. DIMENSION IN BRACKET IS IN MILLIMETERS.
- 2) PACKAGE LENGTH DOES NOT INCLUDE MOLD FLASH, PROTRUSION OR GATE BURR.
- 3) PACKAGE WIDTH DOES NOT INCLUDE INTERLEAD FLASH OR PROTRUSION.
- 4) LEAD COPLANARITY (BOTTOM OF LEADS AFTER FORMING) SHALL BE 0.004" INCHES MAX.
- 5) PIN 1 IDENTIFICATION HAS HALF OR FULL CIRCLE OPTION.
- 6) DRAWING MEETS JEDEC MO-187, VARIATION AA-T.
- 7) DRAWING IS NOT TO SCALE.

**NOTICE:** The information in this document is subject to change without notice. Please contact MPS for current specifications. Users should warrant and guarantee that third party Intellectual Property rights are not infringed upon when integrating MPS products into any application. MPS will not assume any legal responsibility for any said applications.